

QC-CP3 PRESSURE COMPENSATING VALVE, BYPASS TYPE FOR 3 WAY FLOW CONTROL

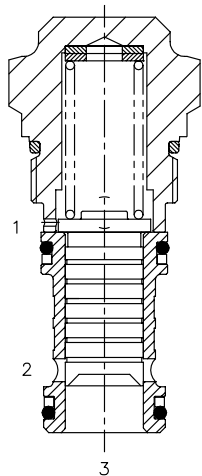

DESCRIPTION

Special cavity, pressure compensating valve, bypass type, for 3 way flow control, normally closed.

OPERATION

The QC-CP3 with an orifice between ports (3) and (1) maintains a constant flow rate from (3) regardless of load pressure changes in the system upstream of (3), or in the bypass leg at (2) as long as pressure at (2) is less than (1). The valve's spool maintains a constant differential pressure across an external orifice, thereby regulating the hydraulic flow rate from (3) to (2), (see options table for pressure ranges). When used with an orifice as described above, as a priority type regulator, delivering pump flow first to (3), then bypassing excess to (2). All ports may be fully pressurized.

FEATURES

- Hardened parts for long life.
- Spring range from 8 to 24 bar.

HYDRAULIC SYMBOL

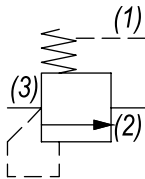

Pressure compensator for 3 way flow control, typically used with an external orifice between ports (3) and (1). Port (1) should sense upstream pressure of orifice.

PERFORMANCE

Actual Test Data (Cartridge Only)

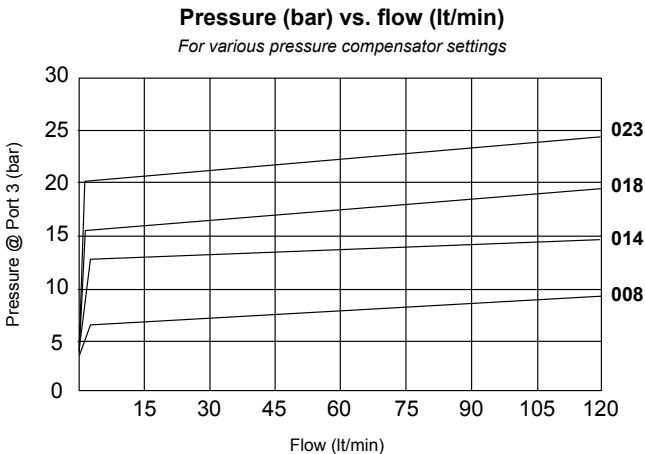

VALVE SPECIFICATIONS

Nominal Flow	33 GPM (120 LPM)
Rated Operating Pressure	3500 PSI (241 bar)
Typical Internal Leakage (150 SSU)	35 ml/min @ 250 bar
Viscosity Range	36 to 3000 SSU (3 to 647 cSt)
Filtration	ISO 18/16/13
Media Operating Temp. Range	-40° to 250°F (-40° to 120°C)
Weight	.35 lbs (.16 kg)
Operating Fluid Media	General Purpose Hydraulic Fluid
Cartridge Torque Requirements	52 ft-lbs (70 Nm)
Cavity	T031 (Special)
Cavity Tools Kit (form tool, reamer, tap)	K-T031
Seal Kit	210902321

WARNING: the specifications/application data shown in our catalogs and data sheets are intended only as a general guide for the product described (herein). Any specific application should not be undertaken without independent study, evaluation, and testing for suitability.



4484 Boeing Drive Rockford, IL 61109 • USA • Phone +1 (815) 397-6628 • Fax +1 (815) 397-2526
mail: delta@delta-power.com • www.delta-power.com



Via Malavolti, 36 • 41122 Modena • ITALY • Phone +39 (059) 254895 • Fax +39 (059) 253512
mail: tecnord@tecnord.com • www.tecnord.com

DIMENSIONS

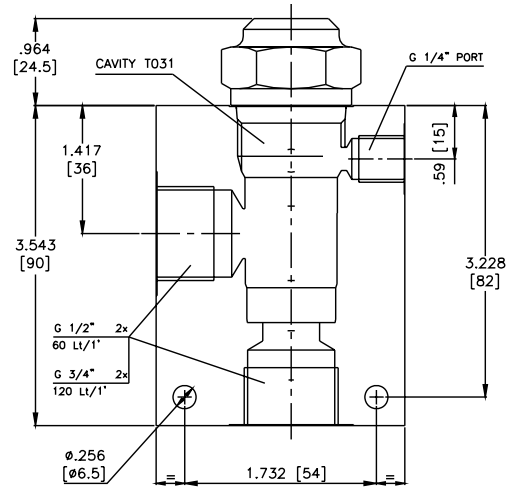
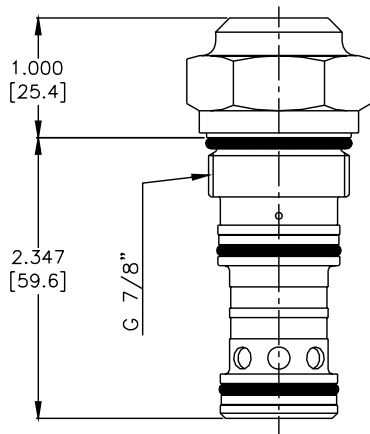
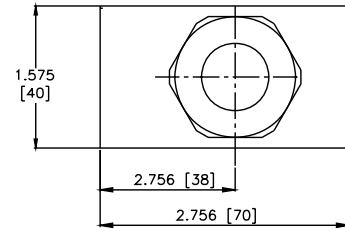
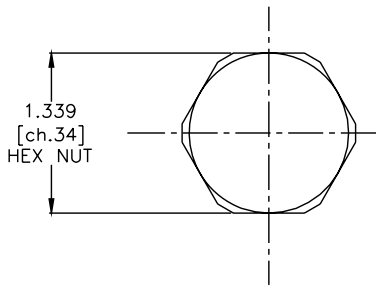

(for bodies style and sizes see section "Accessories")

ORDERING INFORMATION

QC-CP3 - - -

OPTIONS

Buna Standard **00**
Viton Standard **V0**

BODIES

Blank Without Body
N 1/2" BSP Ports
S #8 SAE Ports

PRESSURE SETTINGS

008 8 bar (115 PSI) @ 60 l/min
014 14 bar (200 PSI) @ 60 l/min
018 18 bar (260 PSI) @ 60 l/min
023 23 bar (330 PSI) @ 60 l/min

W 40 / 2017

WARNING: the specifications/application data shown in our catalogs and data sheets are intended only as a general guide for the product described (herein). Any specific application should not be undertaken without independent study, evaluation, and testing for suitability.



4484 Boeing Drive Rockford, IL 61109 • USA • Phone +1 (815) 397-6628 • Fax +1 (815) 397-2526
mail: delta@delta-power.com • www.delta-power.com



Via Malavolti, 36 • 41122 Modena • ITALY • Phone +39 (059) 254895 • Fax +39 (059) 253512
mail: tecnord@tecnord.com • www.tecnord.com