

EQ-S4P 4 WAY 3 POSITION, CYLINDER SPOOL, PROPORTIONAL DIRECTIONAL VALVE

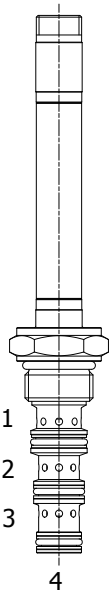

DESCRIPTION

8 size, 3/4-16 thread, "Power" series, solenoid operated, 4 way 3 position, Cylinder Spool, proportional directional valve.

OPERATION

EQ-S4P, when de-energized, blocks flow to all ports. When coil (S1) is energized, flow is allowed from (3) to (4), and from (2) to (1). When coil (S2) is energized, flow is allowed from (3) to (2), and from (4) to (1). Flow is proportional to the current applied to the coil. A compensator must be used to create a pressure compensated flow control function.

FEATURES

- Hardened parts for long-life.
- Industry common cavity.
- Excellent linearity and low hysteresis characteristics.
- Cartridges are voltage interchangeable.
- Optional coil voltages and terminations available.
- Unitized, molded coil design.
- Continuous duty rated solenoid.

HYDRAULIC SYMBOL

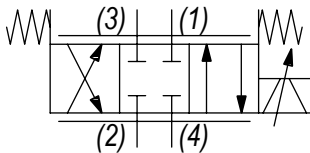

PERFORMANCE

Flow vs. Current

Coil 12VDC – 100 Hz PWM – Oil 26cSt (121 SSU) @ 50°C (122°F)
Operating curves made with circuit having a pressure drop of 14bar

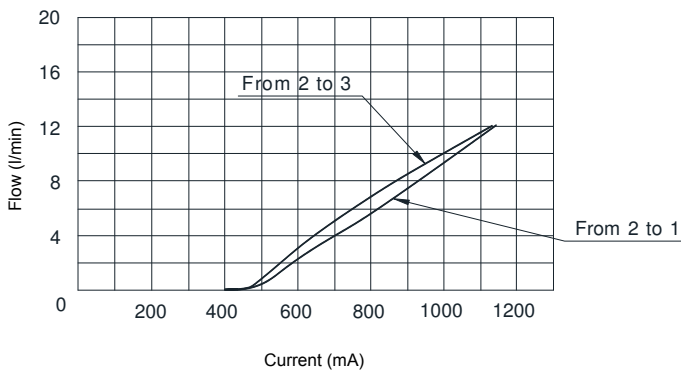

VALVE SPECIFICATIONS

Flow Range	See curves for various versions
Max System Pressure	3500 PSI (241 bar)
Leakage	10 cu-in/min 160 cc/min bar @ 210 bar
Hysteresis	±5%
Viscosity Range	36 to 3000 SSU (3 to 647 cSt)
Filtration	ISO 18/16/13
Media Operating Temp. Range	-30°C / +100°C
Operating Fluid Media	General Purpose Hydraulic Fluid
Cartridge Torque Requirements	18 ft-lbs (26 Nm)
Coil Nut Torque Requirements	2-3 ft-lbs (3-4 Nm)
Cavity	POWER 4W
Cavity Tools Kit (form tool, reamer, tap)	40500029

COIL SPECIFICATIONS

Current Supply Characteristics	PWM (Pulse Width Modulation)
Rated Current Range	400-1300 mA
PWM or Super-Imposed	
Dither Frequency	100-200 Hz
Coil Resistance (12 VDC)	6.85 Ohm ±5% at 68°F (20°C)

WARNING: the specifications/application data shown in our catalogs and data sheets are intended only as a general guide for the product described (herein). Any specific application should not be undertaken without independent study, evaluation, and testing for suitability.



4484 Boeing Drive Rockford, IL 61109 • USA • Phone +1 (815) 397-6628 • Fax +1 (815) 397-2526
mail: delta@delta-power.com • www.delta-power.com



Via Malavolti, 36 • 41122 Modena • ITALY • Phone +39 (059) 254895 • Fax +39 (059) 253512
mail: tecnord@tecnord.com • www.tecnord.com

DIMENSIONS

Pressure Drop vs. Flow
Oil 26cSt (121 SSU)@ 50°C (122°F)

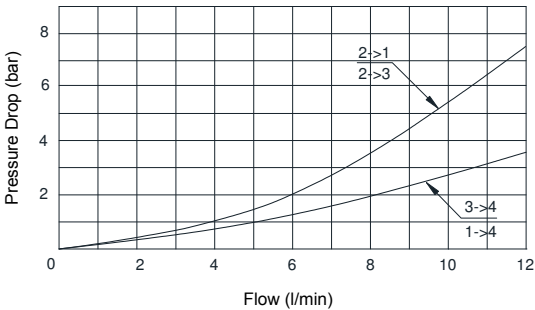

Pressure Compensation from Inlet to Work Port
Oil 26cSt (121 SSU)@ 50°C (122°F)

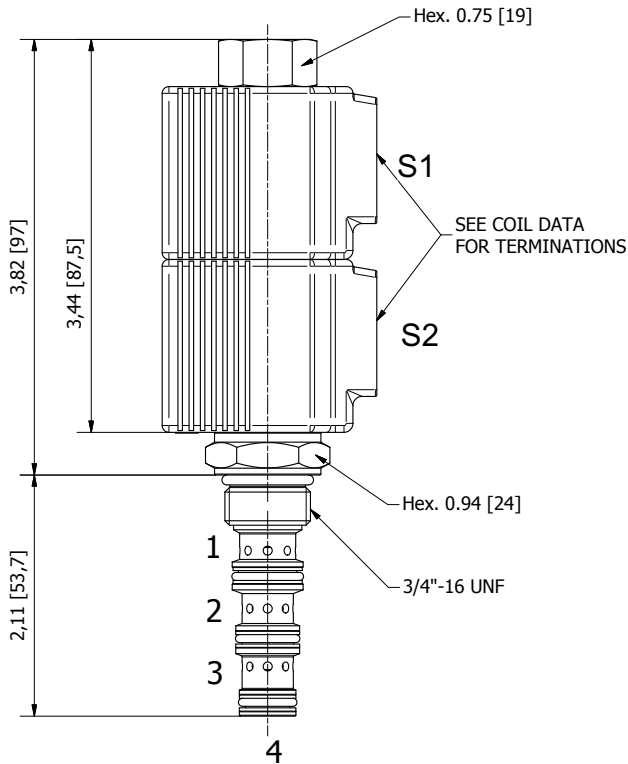
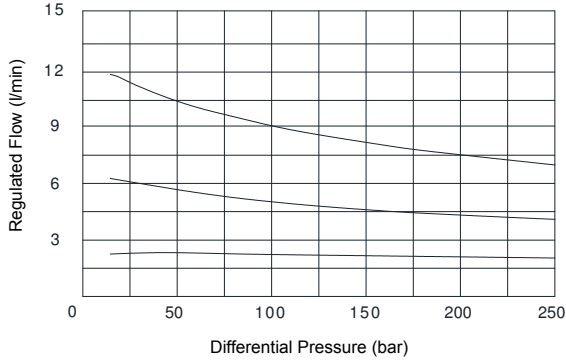

(for bodies style and sizes see section "Accessories")

ORDERING INFORMATION

Approximate Coil Weight: .47 lbs (.21 kg)

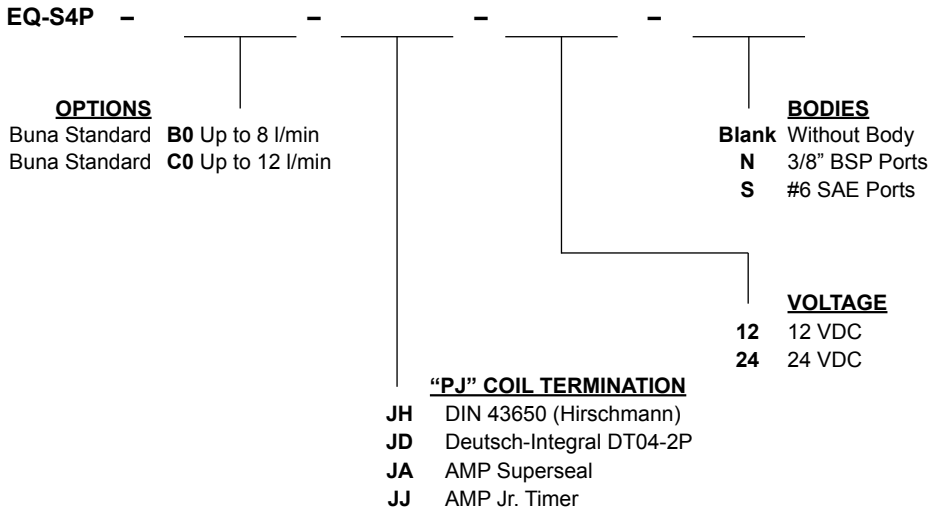

NOTE: for other seals, consult factory.

W/11 / 2018

WARNING: the specifications/application data shown in our catalogs and data sheets are intended only as a general guide for the product described (herein). Any specific application should not be undertaken without independent study, evaluation, and testing for suitability.



4484 Boeing Drive Rockford, IL 61109 • USA • Phone +1 (815) 397-6628 • Fax +1 (815) 397-2526
mail: delta@delta-power.com • www.delta-power.com



Via Malavolti, 36 • 41122 Modena • ITALY • Phone +39 (059) 254895 • Fax +39 (059) 253512
mail: tecnord@tecnord.com • www.tecnord.com